

40005893

- DE** Montageanleitung
- ES** Instrucciones de montaje
- FR** Instructions de montage
- GB** Assembly Instructions
- IT** Istruzione di montaggio
- NL** Montagehandleiding
- PL** Instrukcja montazu

Original mounting instruction 02/05/20 PVA

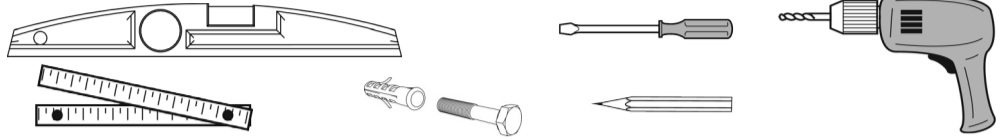
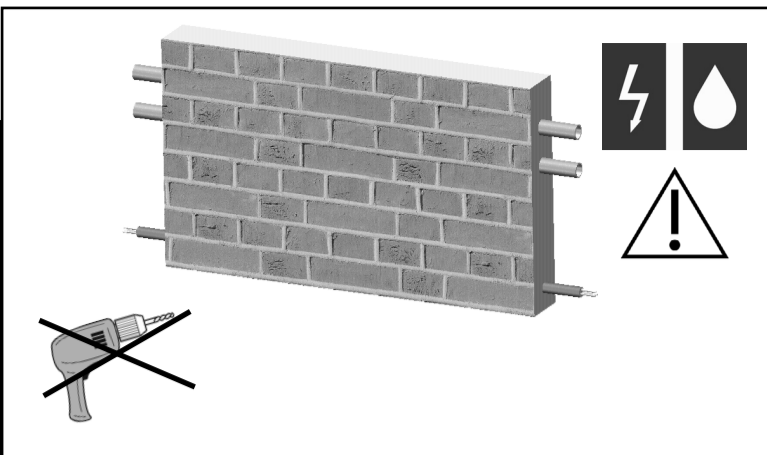

## HX - SHX - HXD - SHXD - MX - MXD ROV - ROVD - ROM - ROMD

**HX1  
ROV**

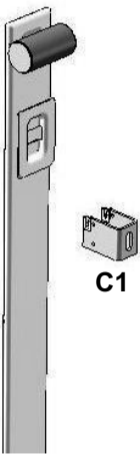

**HXD1  
ROVD**

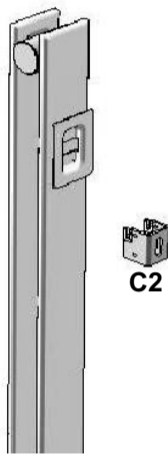

**HX2  
ROV**

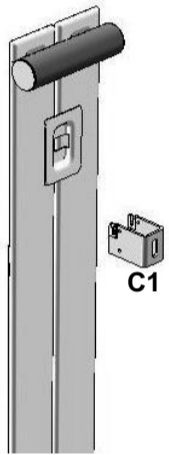

**HXD2  
ROVD**

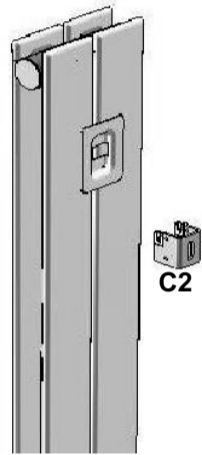

**HX / SHX / ROV ≥ 3  
MX - ROM**

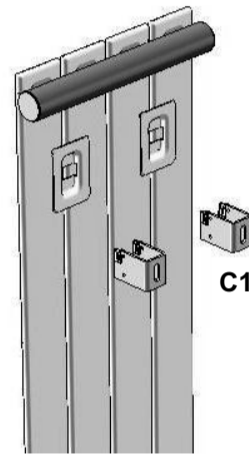

**HXD / SHXD / ROVD ≥ 3  
MXD - ROMD**

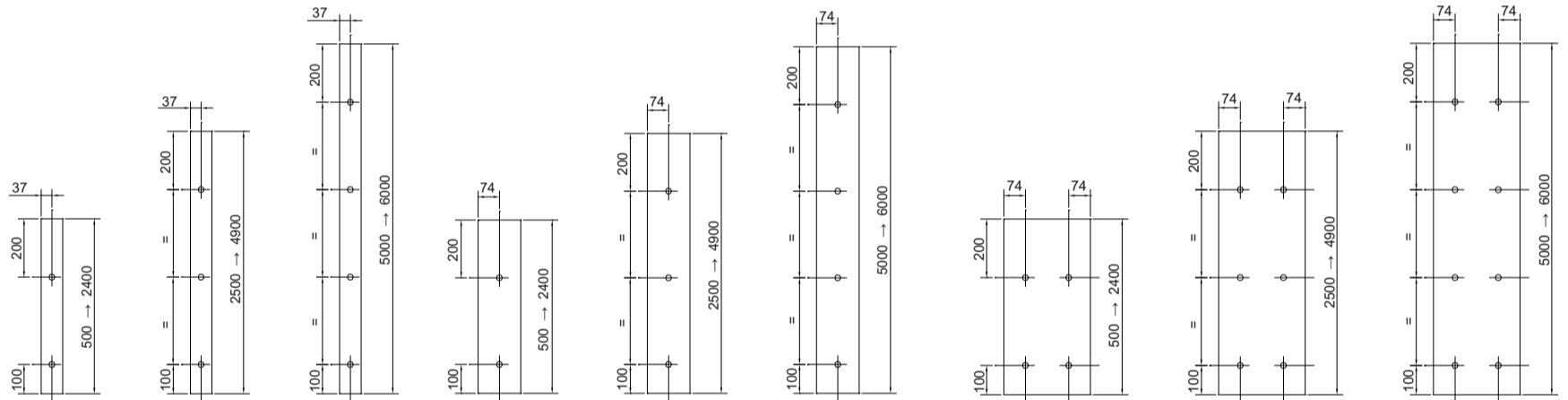
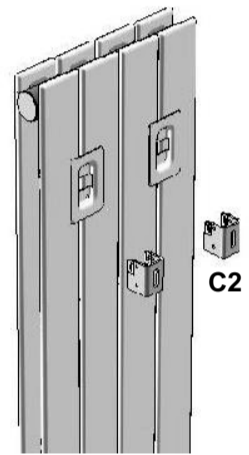

## VX - VXD - SVXD - ROH - ROHD

**VX1 - VXD1  
ROH1 - ROHD1**

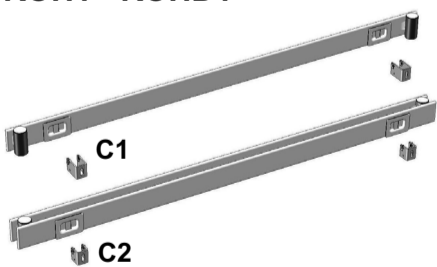

**VX2 - VXD2  
ROH2 - ROHD2**

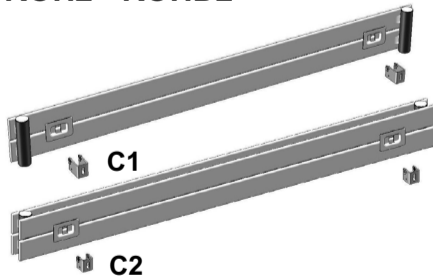

**VX3 - VXD3  
ROH3 - ROHD3**

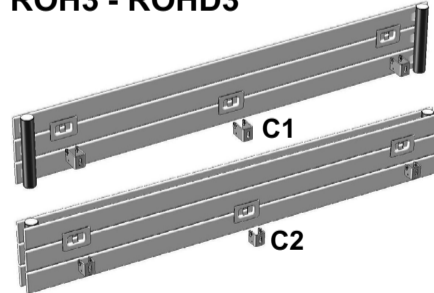

**VX - VXD - SVXD ≥ 4  
ROH - ROHD ≥ 4**

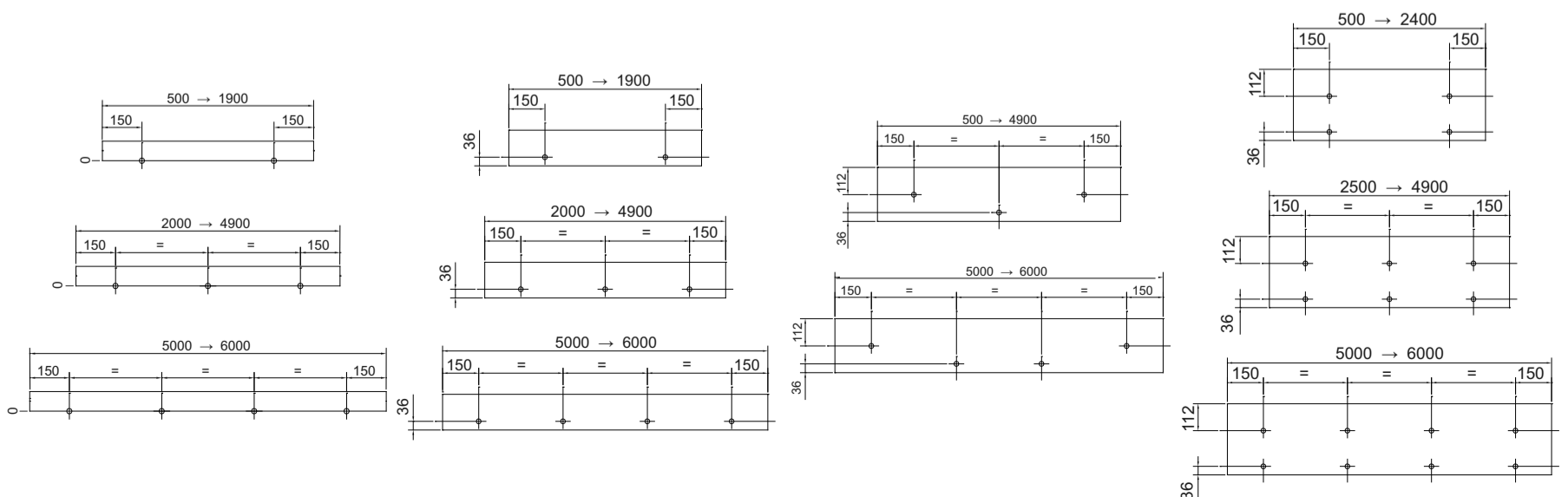
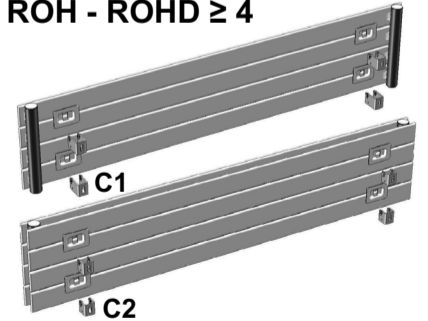

# VLX - ROHL

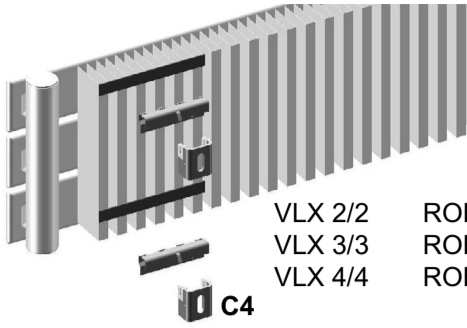

VLX 2/2 ROHL 2/2  
VLX 3/3 ROHL 3/3  
VLX 4/4 ROHL 4/4

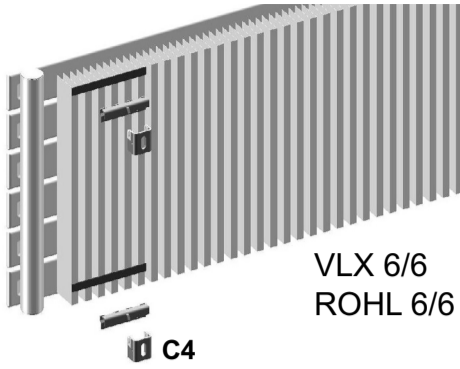
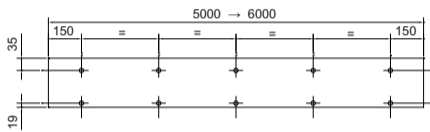
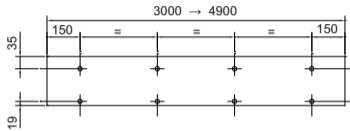
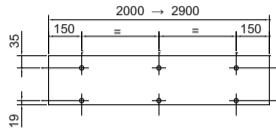
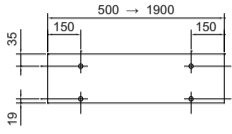

VLX 6/6  
ROHL 6/6

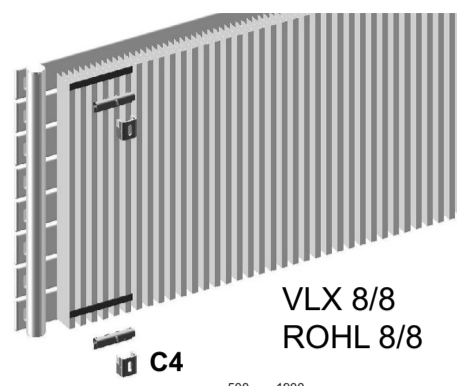
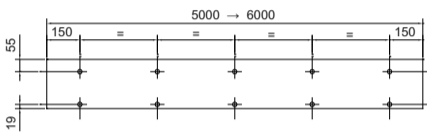
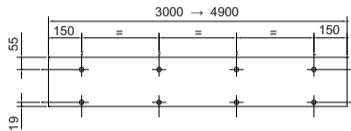
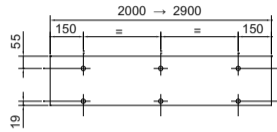
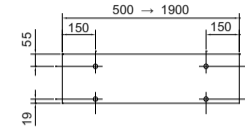

VLX 8/8  
ROHL 8/8

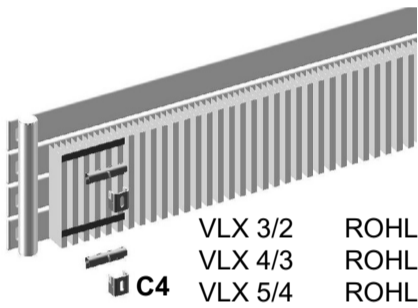
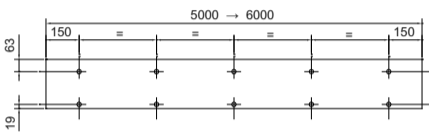
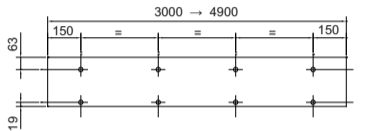
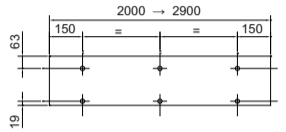
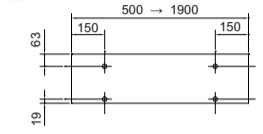

VLX 3/2 ROHL 3/2  
VLX 4/3 ROHL 4/3  
VLX 5/4 ROHL 5/4

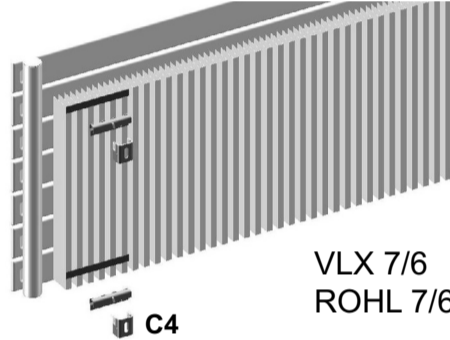
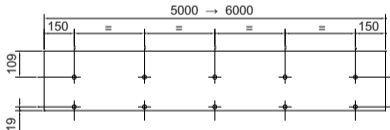
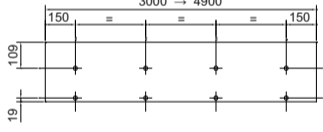
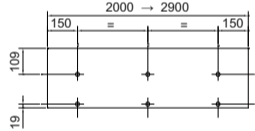
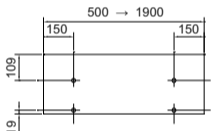

VLX 7/6  
ROHL 7/6

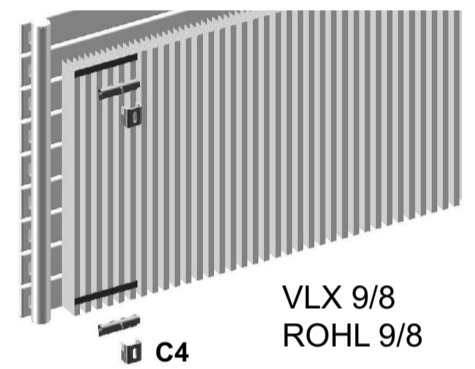
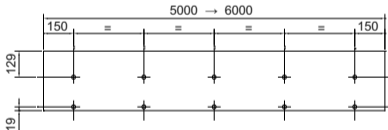
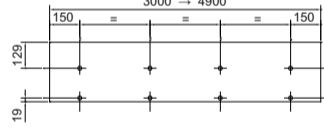
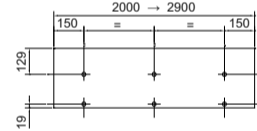
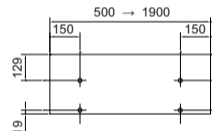

VLX 9/8  
ROHL 9/8

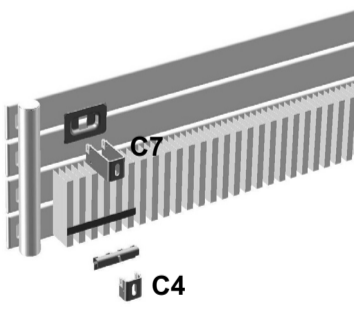
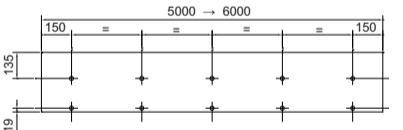
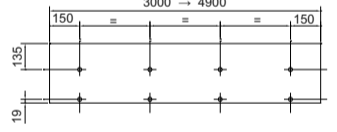
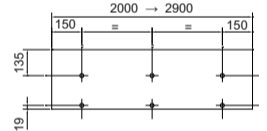
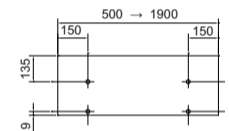

C4

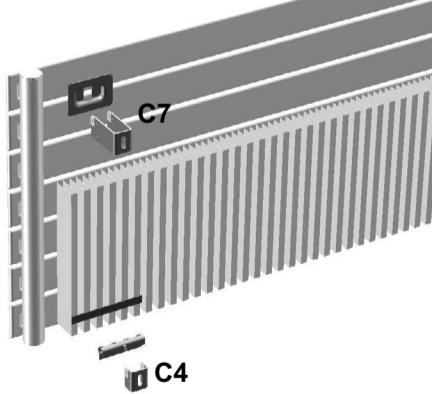
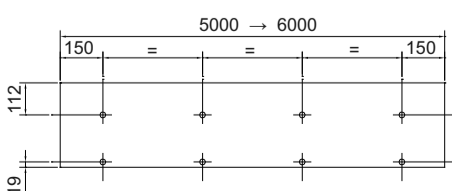
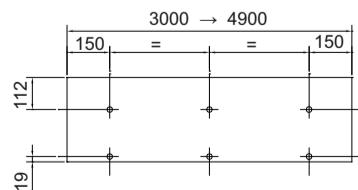
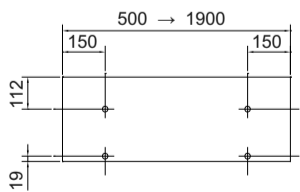

C4

VLX 4/2 ROHL 7/4  
VLX 5/2 ROHL 8/2  
VLX 5/3 ROHL 8/3  
VLX 6/2 ROHL 8/4  
VLX 6/3 ROHL 8/6  
VLX 6/4 ROHL 9/2  
VLX 7/2 ROHL 9/3  
VLX 7/3 ROHL 9/4  
VLX 7/4 ROHL 9/6  
VLX 8/2 ROHL 10/2  
VLX 8/3 ROHL 10/3  
VLX 8/4 ROHL 10/4  
VLX 8/6 ROHL 10/6  
VLX 9/2 ROHL 10/8  
VLX 9/3 ROHL 7/3

- **Entlüftung mit dirigierbarem Wasserstrahl:** Schrauben Sie die Entlüftung auf den Heizkörper, so dass der Dichtungsring die Dichtigkeit gewährleistet (**15 Nm max**).



- **Purgador de chorro orientable:** Apriete con moderación el purgador en el radiador para obtener la hermeticidad por medio de la junta torica (**15 Nm max**).

- **Purgeur à jet orientable:** Serrez modérément le purgeur sur le radiateur pour faire étanchéité à l'aide du joint torique (**15 Nm max**).

- **Swivelling air bleed valve:** Tighten the bleed valve moderately on the radiator with the o-ring to ensure watertightness. (**15 Nm max**).

- **Rubinetto di sfiato a getto orientabile:** Serrare moderatamente il rubinetto di sfiato situato sul radiatore per ottenere la tenuta mediante O-ring (**15 Nm max**).

- **Oriënteerbare ontlufter:** De ontlufter met mate op de radiator aanschroeven zodanig dat met de rubberen dichtingsring een hechte dichting bekomen wordt (**15 Nm max**).

- **Odpowietrzanie przy użyciu odpowietrznika obrotowego:** Umiarkowanie dokręcić odpowietrznik do grzejnika, zapewniając szczelność przy użyciu uszczelki (**15 Nm max**).

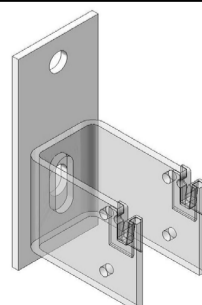

Befestigungen für hohle und brüchige Wände  
Fijaciones para muros huecos y frágiles  
Fixations pour mur creux et friables  
Fixing for hollow and friable walls  
Attachi per muri cavi e friabili  
Bevestigingen voor holle en broekelige muren  
Mocowania do pustych ścian i kruche